



Drawing:
4 oz Imperial Round 20/415

Stock Code:
000400050211700

Manufacturing Process:
Stretch Blow Molding

Overflow Capacity:
127 - 139 ml (4.3 - 4.7 oz)

Gram Weight:
15 ± 1

Neck Finish:
20/415

Base Width (A):
1.537 ± 0.050

Overall Height (B):
5.484 ± 0.050

Max Print Area (Height):
3.750"

Max Print Area (Width):
4.500"

Case Pack: 480

Case Weight (lb): 18.0± 1.0

Cases Per Pallet: 25

Box Dimensions:
23 5/8 x 15 9/16 x 17

Stock Material:



FRONT VIEW

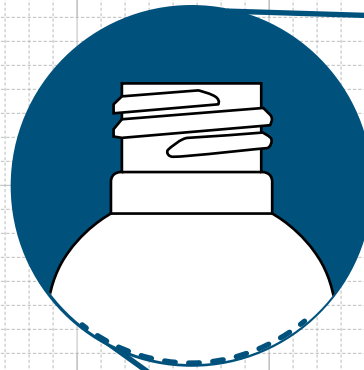
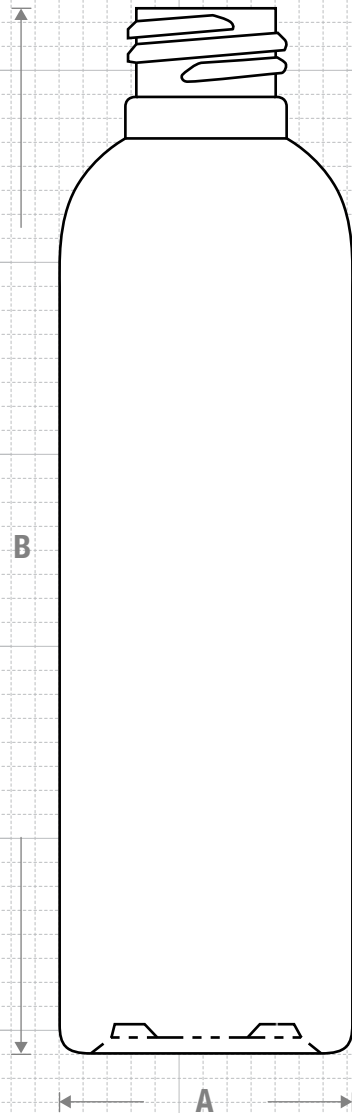

NECK & THREAD DETAIL

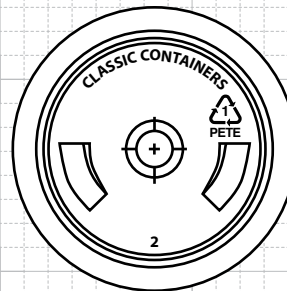
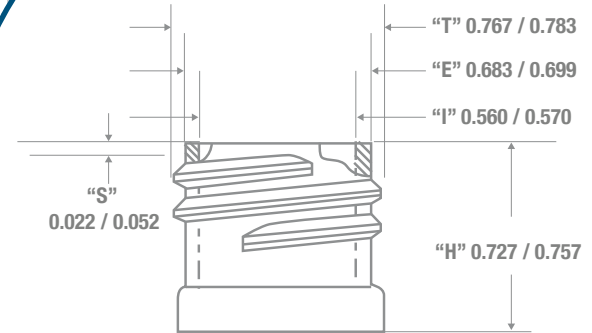

BOTTOM VIEW

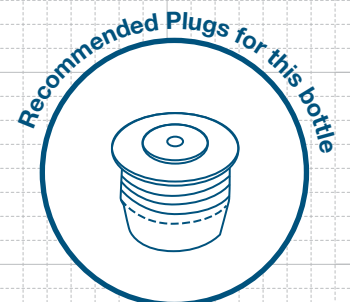
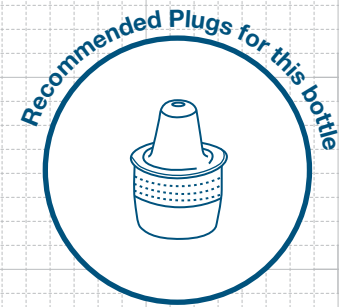

FRICITION FIT

CLASSIC CONTAINERS INC
1700 S. Hellman Ave.
Ontario, CA 91761
Phone: 909-930-3610
e-mail: info@classiccontainers.com
www.classiccontainers.com

PRINTING SPECIFICATIONS: 4 oz IMPERIAL ROUND 20/415 PETE

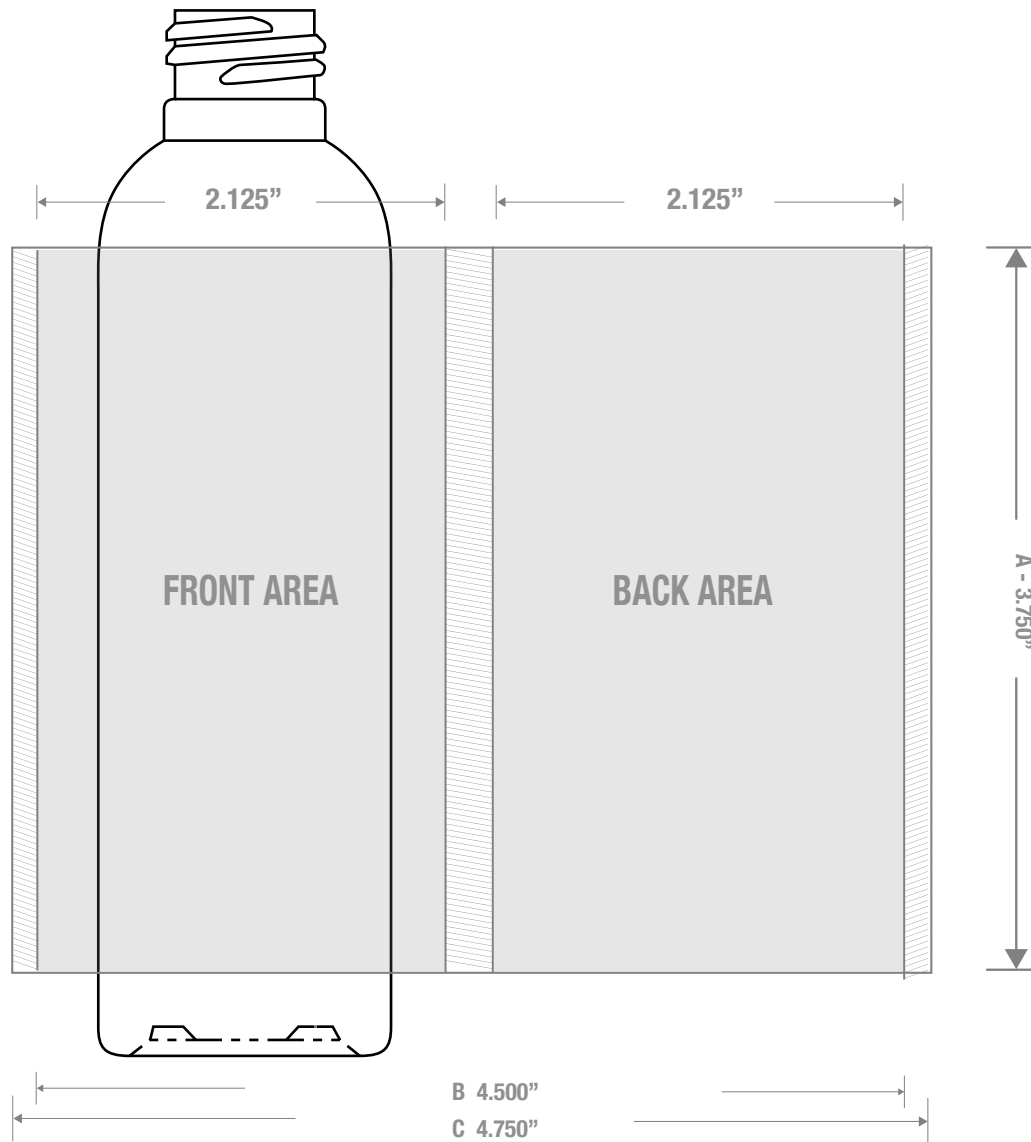

1700 S Hellman Ave, Ontario, California 91761
Phone: (909) 930-3610 | Fax: (909) 930-3640
e-mail: info@classiccontainers.com
www.classiccontainers.com

A - Total Height.
B - Max. Decorating Area.
C - Total bottle circumference.
▨ - Unprintable area.

LABELING SPECIFICATIONS: 4 oz IMPERIAL ROUND 20/415 PETE



1700 S Hellman Ave, Ontario, California 91761
Phone: (909) 930-3610 | Fax: (909) 930-3640
e-mail: info@classiccontainers.com
www.classiccontainers.com

A - Total Height.
B - Max. Decorating Area.
C - Total bottle circumference.
☐ - Unprintable area.

Printing over a mold part line is discouraged due to the fact that may lead to missing characters or un-printed.