

**NECK & THREAD DETAIL**

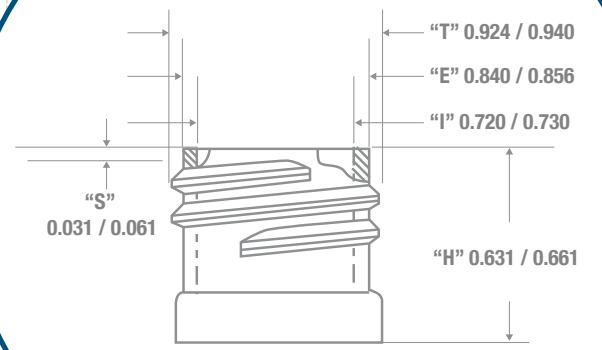

**FRONT VIEW**

**SIDE VIEW**

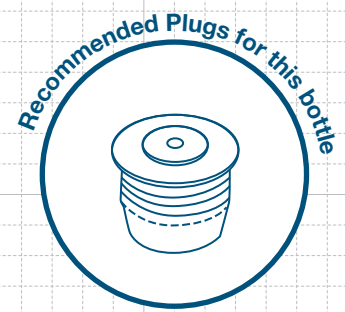
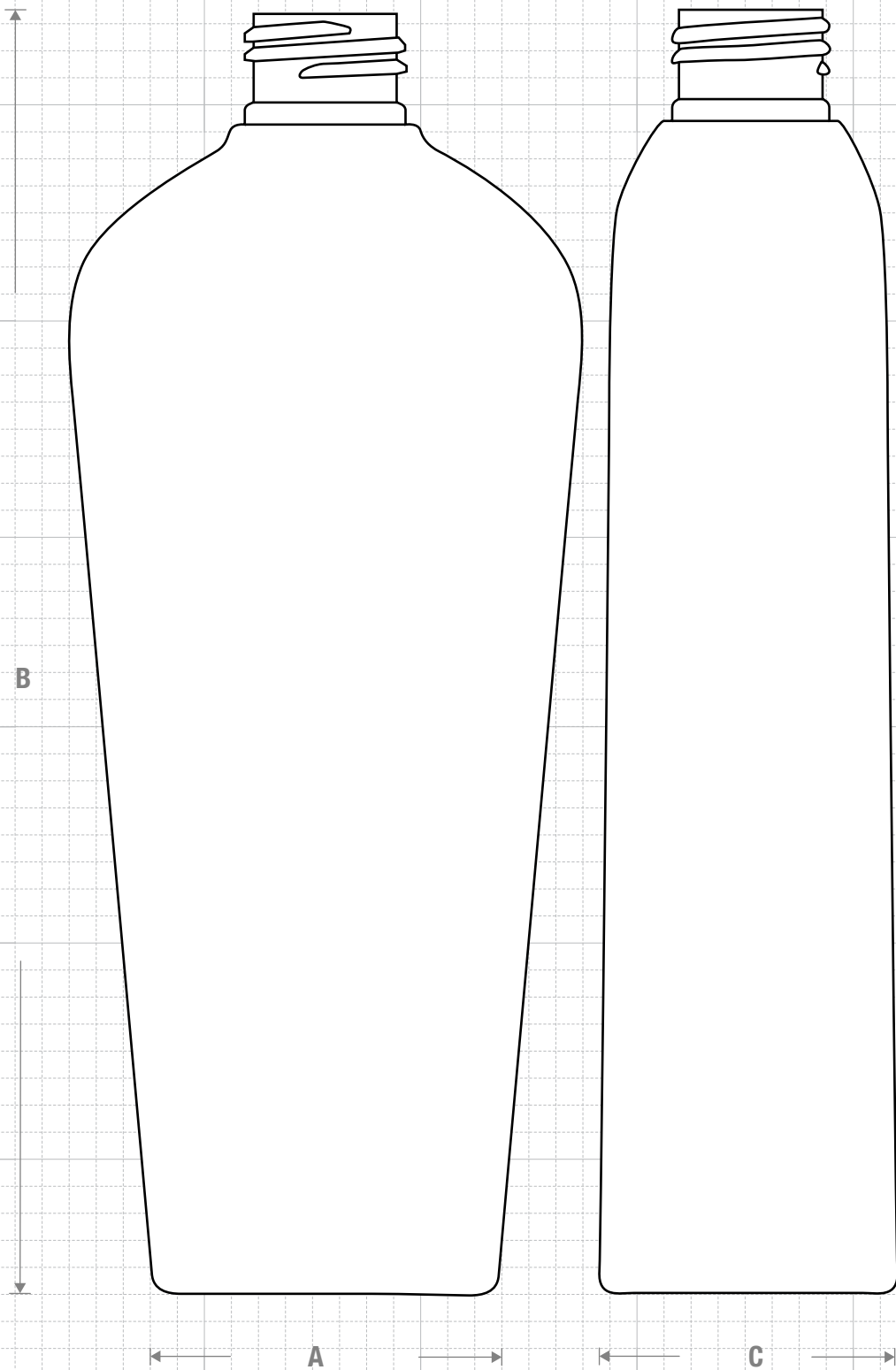

**FRICITION FIT**

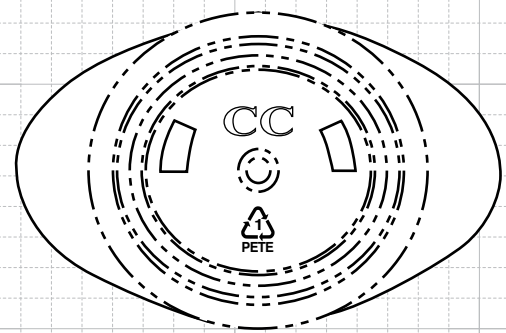

**BOTTOM VIEW**



**CLASSIC CONTAINERS INC**  
 1700 S. Hellman Ave.  
 Ontario, CA 91761  
 Phone: 909-930-3610  
 e-mail: info@classiccontainers.com  
 www.classiccontainers.com

Drawing:  
**12 oz Vail Oval 24/410**

Gram Weight:  
**31 ± 1**

Max Print Area (Height):  
**5.100"**

Cases Per Pallet: **16**

Stock Code:  
**001200100241700**

Neck Finish:  
**24/410**

Max Print Area (Width):  
 Shoulder: **1.800"** Base: **1.125"**

Box Dimensions:  
**24 7/16 x 18 1/2 x 23**

Manufacturing Process:  
**Stretch Blow Molding**

Base Width (A) Base Deep (C):  
**2.100± 0.050 1.900± 0.050**

Case Pack: **270**

Stock Material:



Overflow Capacity:  
**366 - 384 ml (12.4 - 13.0 oz)**

Overall Height (B):  
**7.543 ± 0.050**

Case Weight (lb): **21.4 ± 0.6**

Rev #2 01/2016

Drawing not exactly to size.

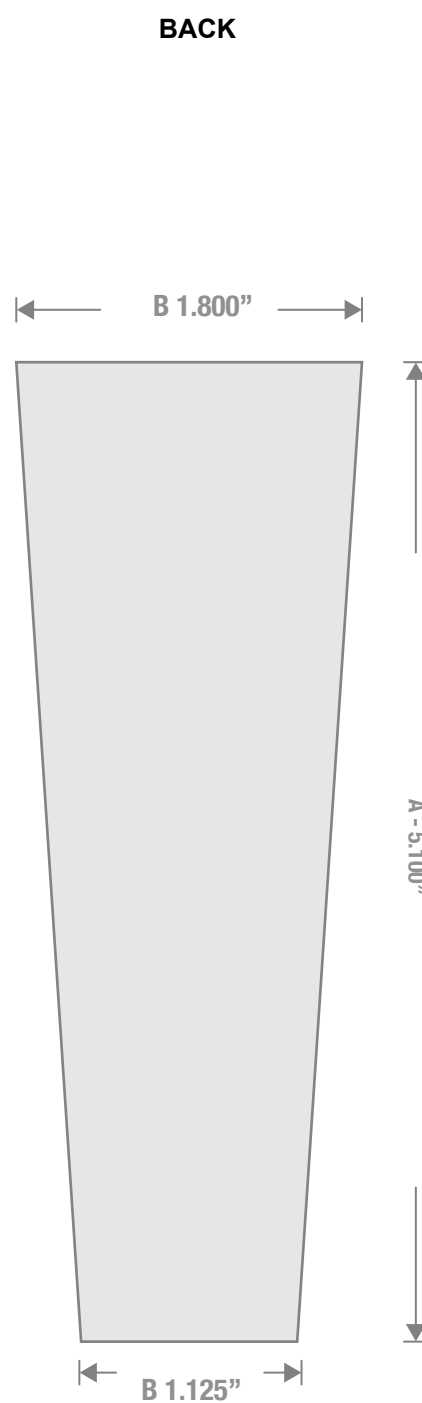
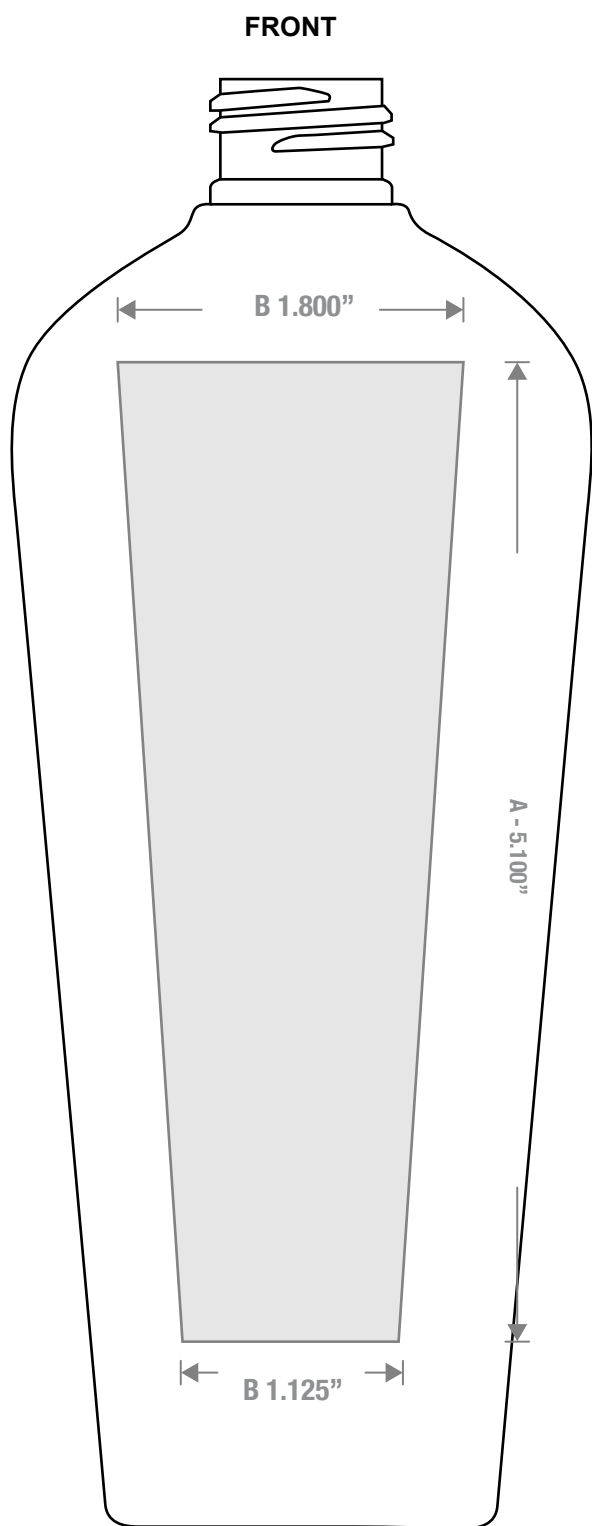

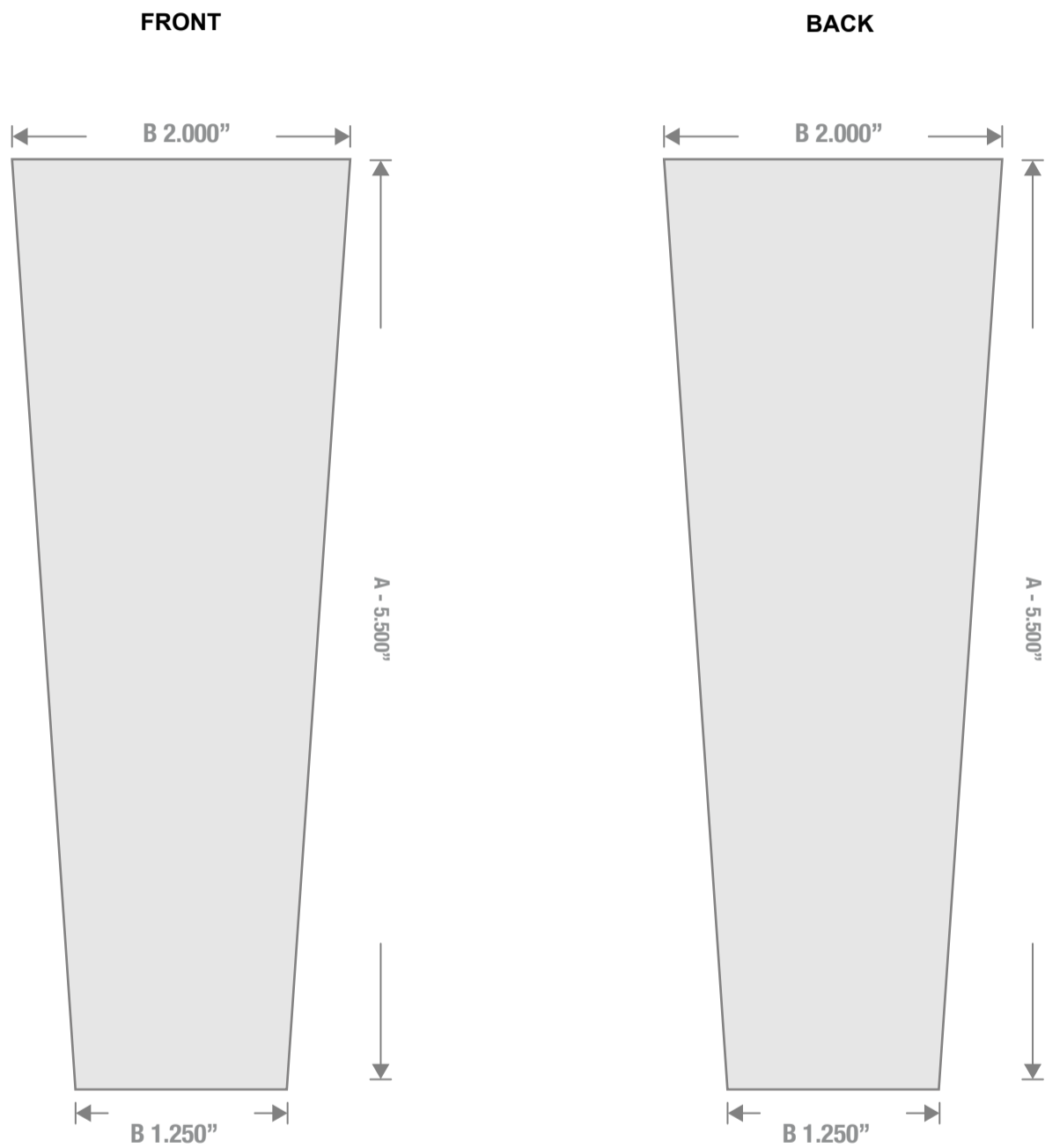

1700 S Hellman Ave, Ontario, California 91761  
Phone: (909) 930-3610 | Fax: (909) 930-3640  
e-mail: [info@classiccontainers.com](mailto:info@classiccontainers.com)  
[www.classiccontainers.com](http://www.classiccontainers.com)

A - Total Height.  
B - Max. Decorating Area.