

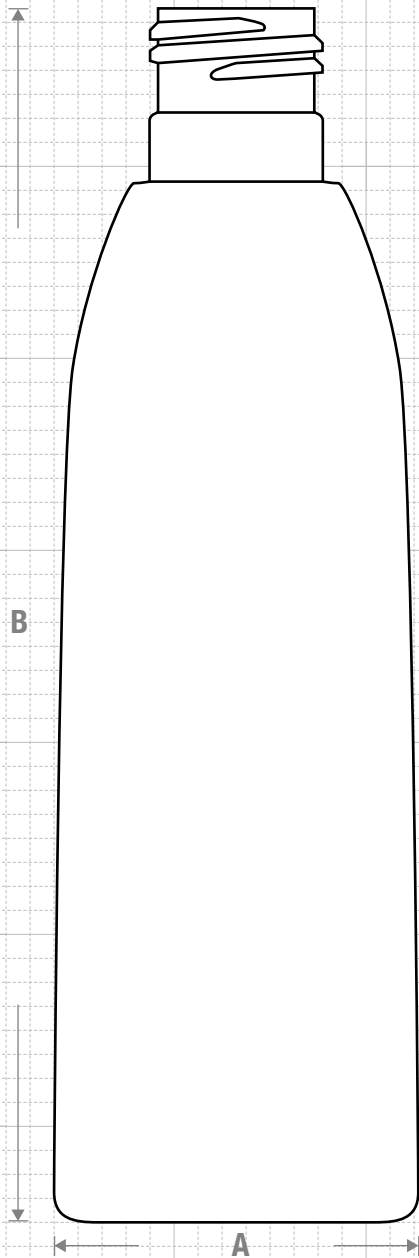

FRONT VIEW



Drawing:
6 oz Evolution 24/415

Stock Code:
000600330251700

Manufacturing Process:
Stretch Blow Molding

Overflow Capacity:
183 - 195 ml (6.2 - 6.6 oz)

Gram Weight:
20 ± 1

Neck Finish:
24/415

Base Width (A):
1.741 ± 0.050

Overall Height (B):
6.319 ± 0.050

Max Print Area (Height):
3.625"

Max Print Area (Width):
5.250"

Case Pack: 606

Case Weight (lb): 29.6 ± 1.3

Cases Per Pallet: 16

Box Dimensions:
24 7/16 x 18 1/2 x 23

Stock Material:



CLASSIC CONTAINERS INC
1700 S. Hellman Ave.
Ontario, CA 91761
Phone: 909-930-3610
e-mail: info@classiccontainers.com
www.classiccontainers.com

NECK & THREAD DETAIL

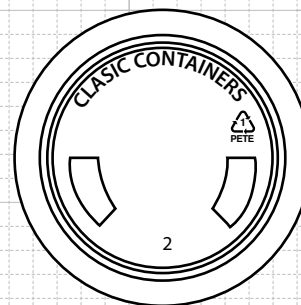
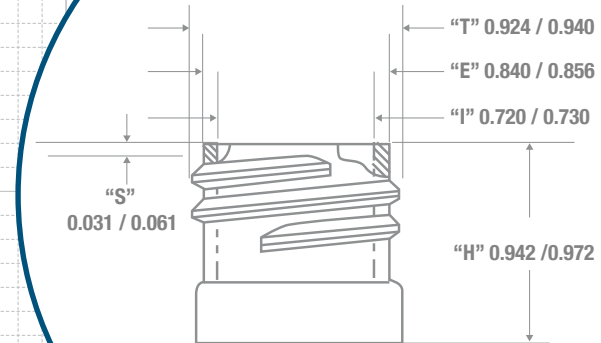
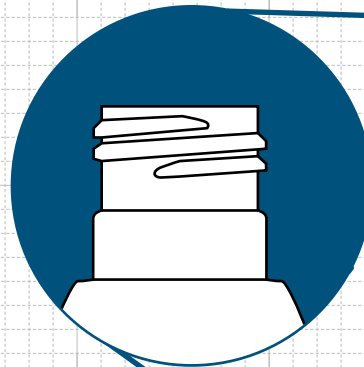

BOTTOM VIEW

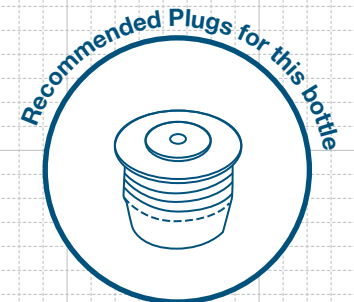

FRICTION FIT