

FRONT VIEW

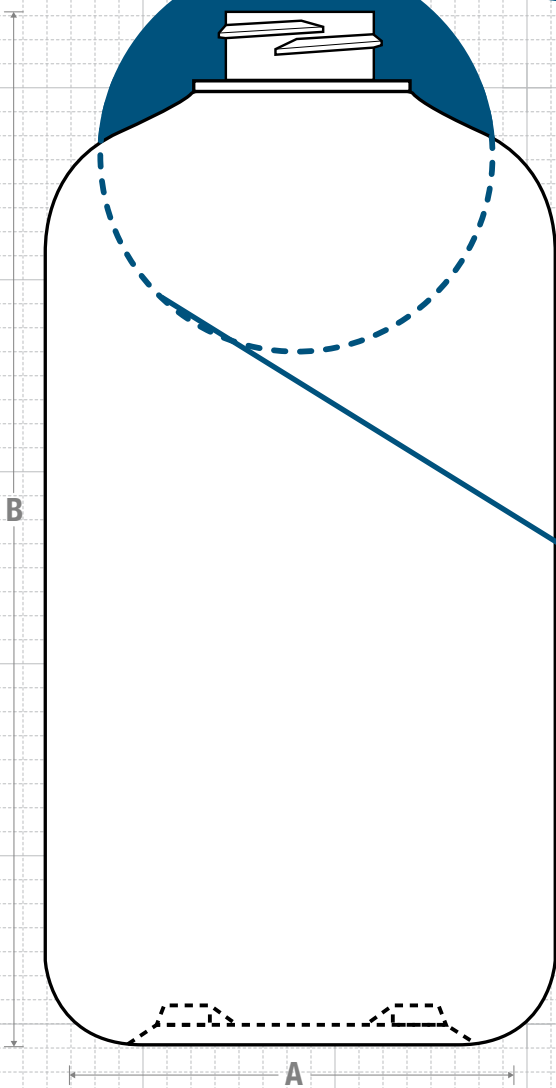

NECK & THREAD DETAIL

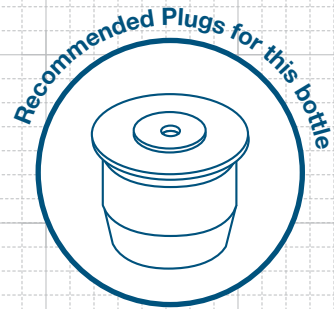
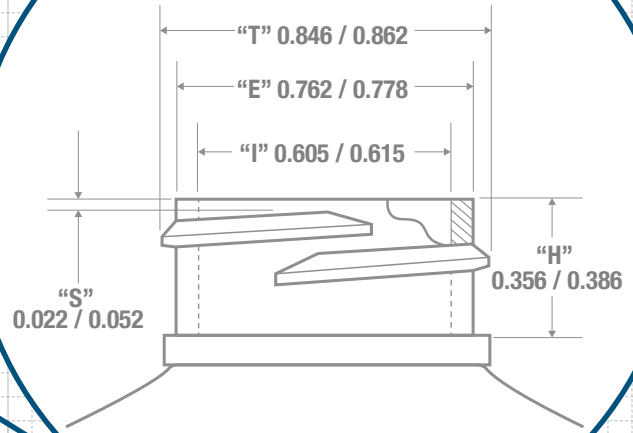

FRICTION FIT

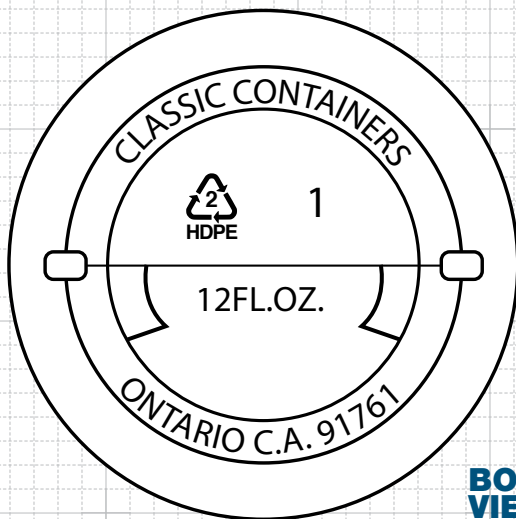

BOTTOM VIEW

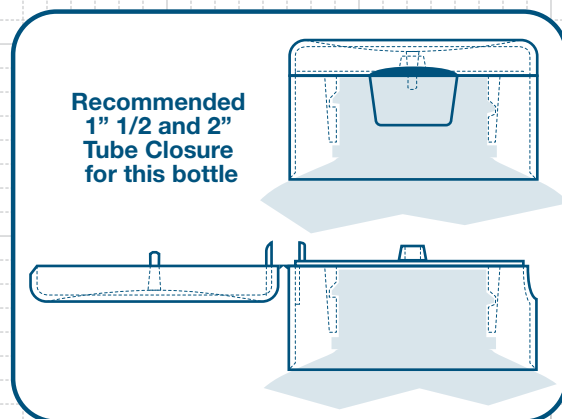

CLASSIC CONTAINERS INC
 1700 S. Hellman Ave.
 Ontario, CA 91761
 Phone: 909-930-3610
 e-mail: info@classiccontainers.com
 www.classiccontainers.com

Drawing:
12 oz Boston Round 22/400

Gram Weight:
28 ± 2

Max Print Area (Height):
3.438"

Cases Per Pallet: **16**

Stock Code:
001200060220000

Neck Finish:
22/400

Max Print Area (Width):
8.125"

Box Dimensions:
24 7/16 x 18 1/2 x 23

Manufacturing Process:
Extrusion Blow Molding

Base Width (A):
2.650 ± 0.050

Case Pack: **272**

Stock Material:



Overflow Capacity:
380 - 402 ml (12.9 - 13.6 oz)

Overall Height (B):
5.380 ± 0.050

Case Weight (lb): **19.7 ± 1.2**

Rev #4 - 05/2016

Drawing not exactly to size.

PRINTING SPECIFICATIONS: 12 oz BOSTON ROUND

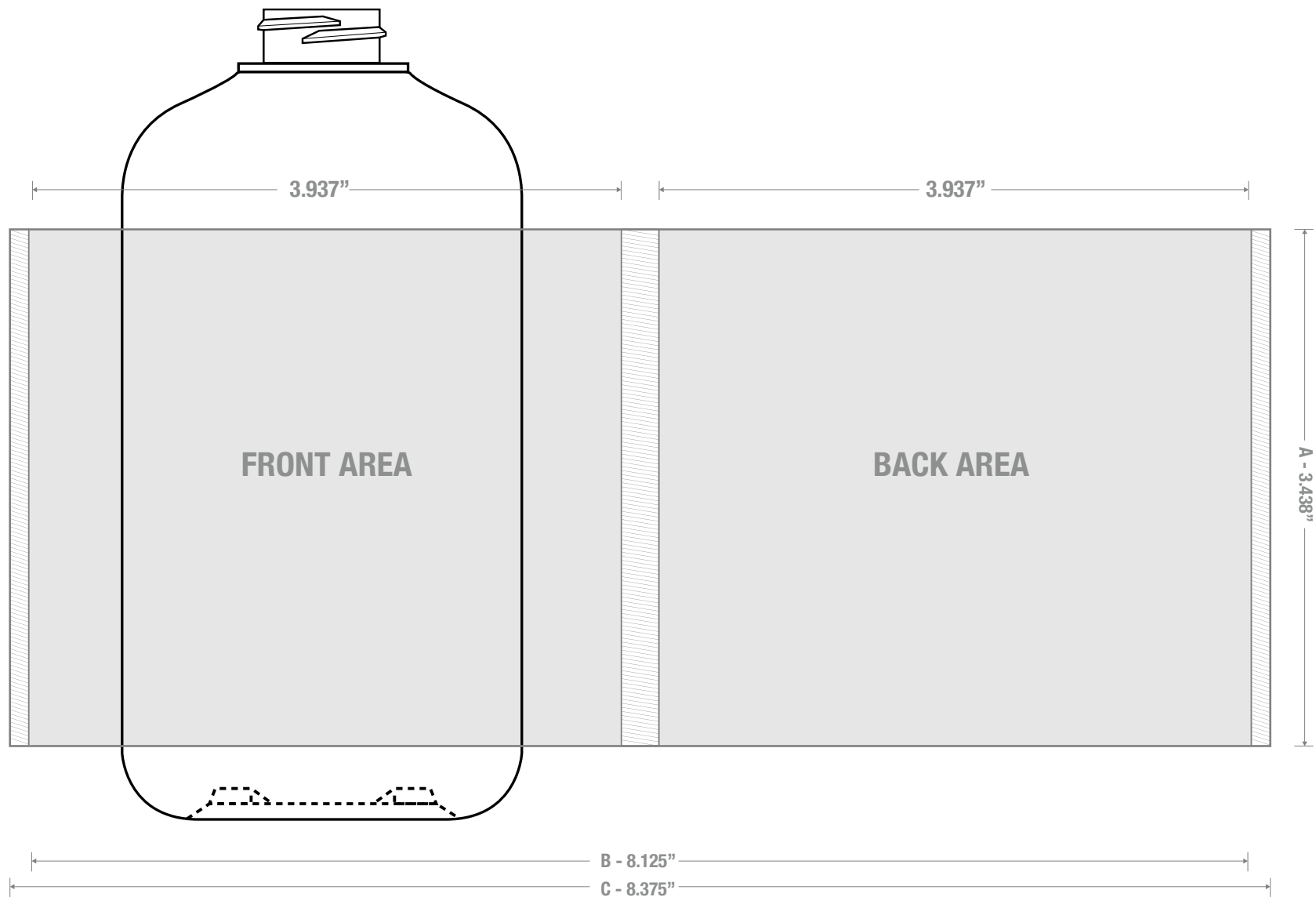

1700 S Hellman Ave, Ontario, California 91761
Phone: (909) 930-3610 | Fax: (909) 930-3640
e-mail: info@classiccontainers.com
www.classiccontainers.com

A - Total Height.
B - Max. Decorating Area.
C - Total bottle circumference.
▨ - Unprintable area.

LABELING SPECIFICATIONS: 12 oz BOSTON ROUND

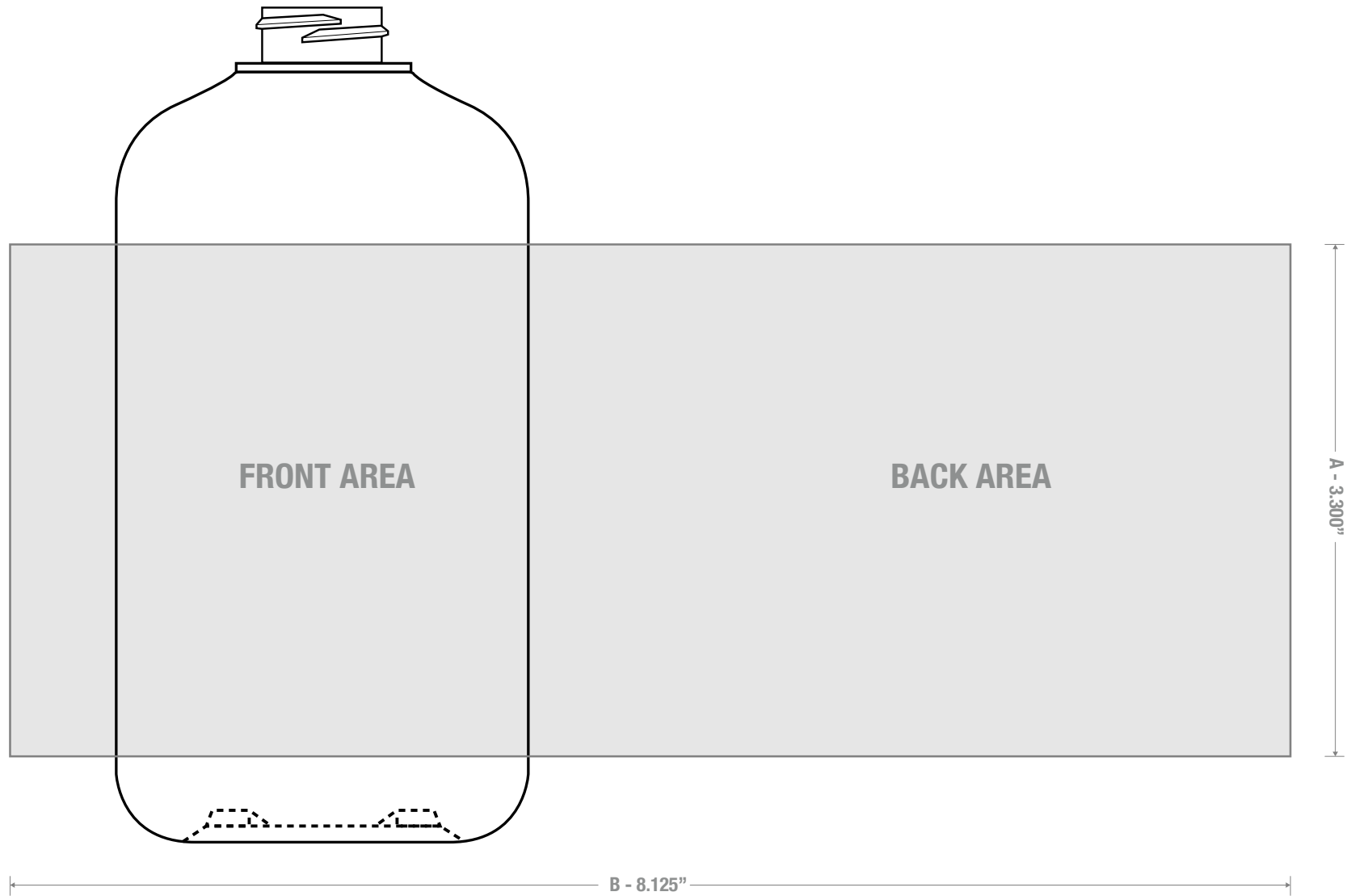

**LASSIC
CONTAINERS
Inc.**

1700 S Hellman Ave, Ontario, California 91761
Phone: (909) 930-3610 | Fax: (909) 930-3640
e-mail: info@classiccontainers.com
www.classiccontainers.com

A - Total Height.
B - Max. Decorating Area.