

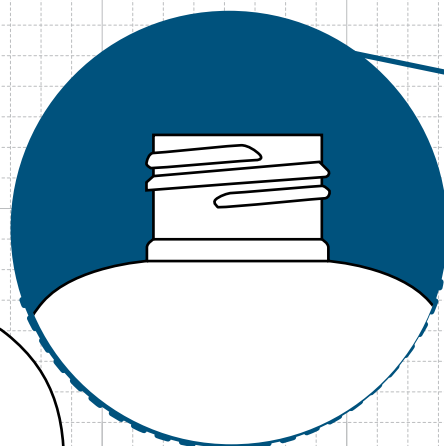

FRONT VIEW

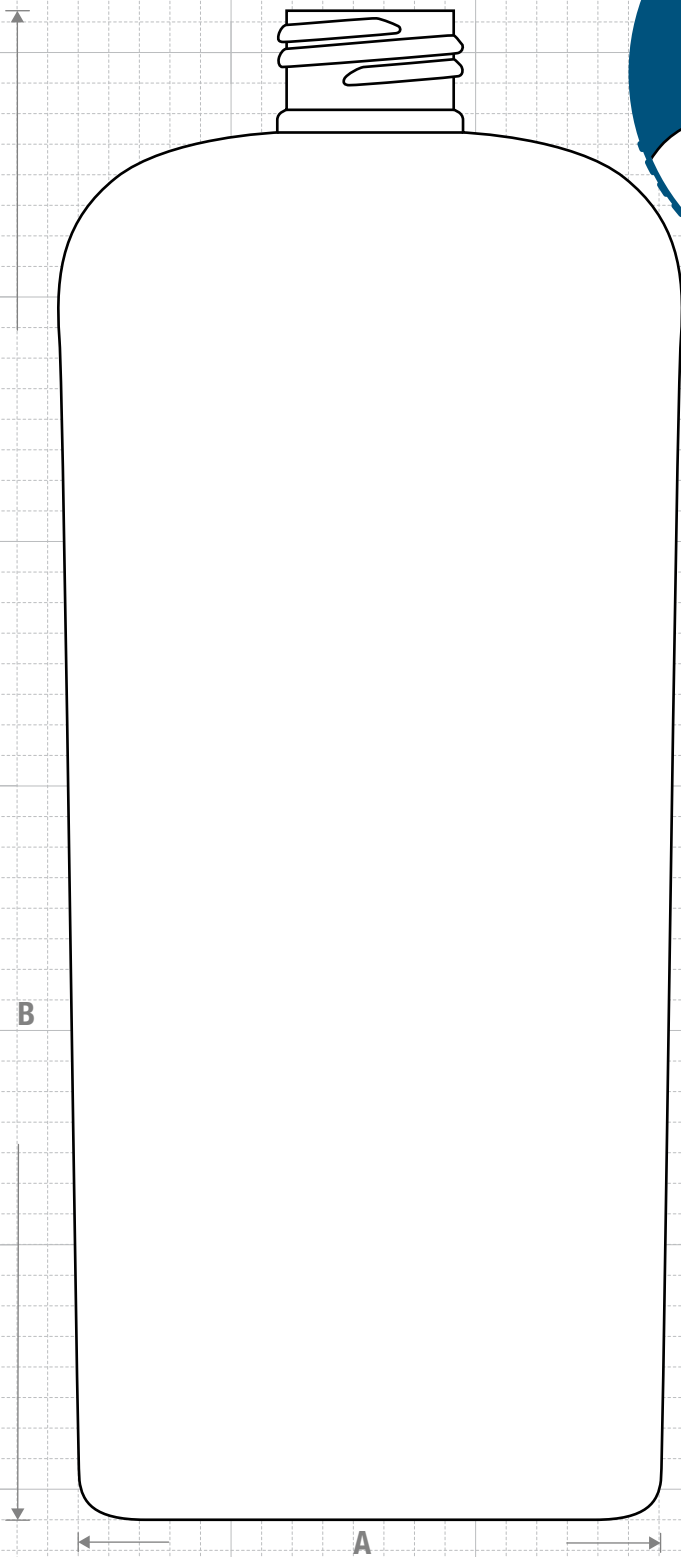

NECK & THREAD DETAIL

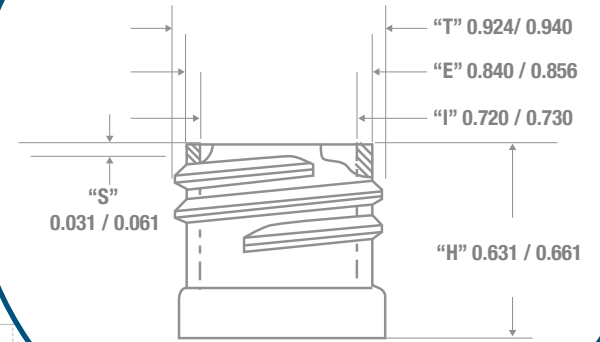

SIDE VIEW

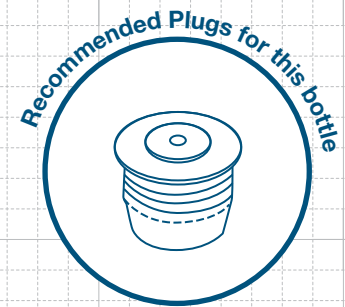
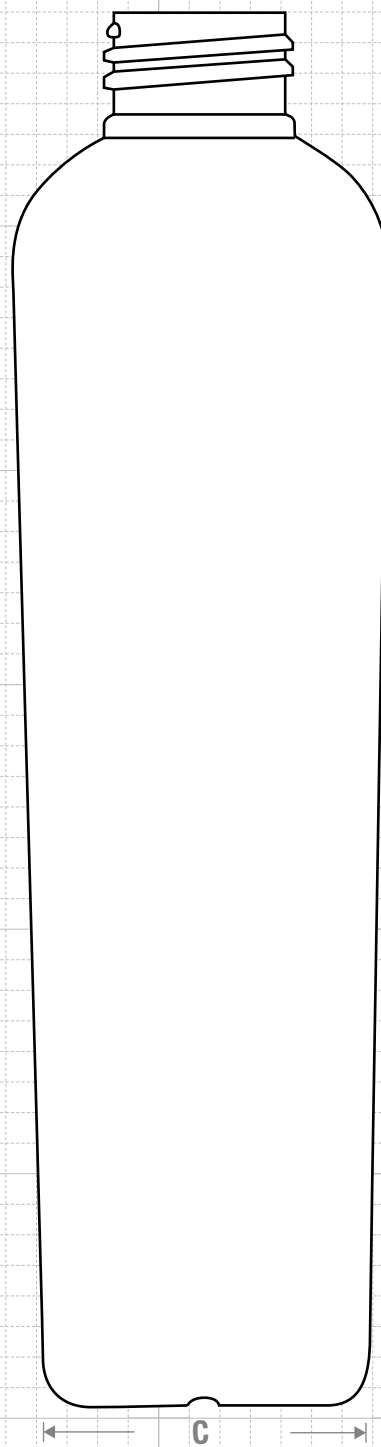

FRICTION FIT

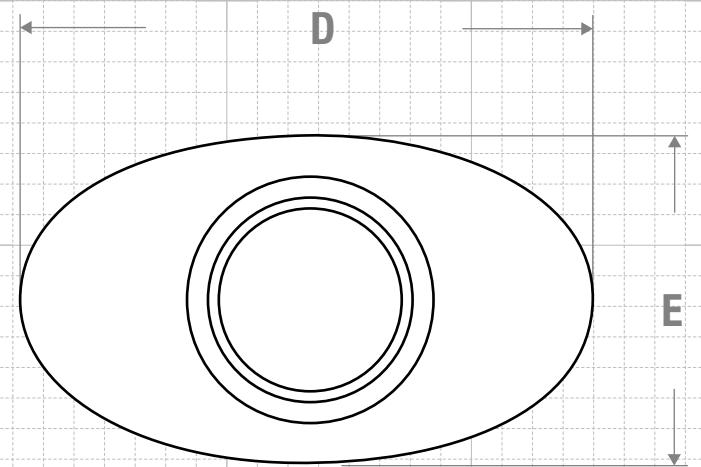

TOP VIEW

D Shoulder Width: 3.235 ± 0.050
E Shoulder Depth: 1.890 ± 0.050

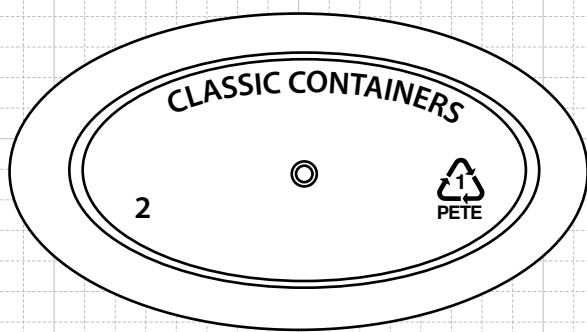

BOTTOM VIEW



CLASSIC CONTAINERS INC
1700 S. Hellman Ave.
Ontario, CA 91761
Phone: 909-930-3610
e-mail: info@classiccontainers.com
www.classiccontainers.com

Drawing:
16 oz Classic Oval 24/410

Gram Weight:
 36 ± 1

Max Print Area (Height):
5.750"

Cases Per Pallet: **16**

Stock Code:
001600230241700

Neck Finish:
24/410

Max Print Area (Width):
2.062"

Box Dimensions:
24 7/16 x 18 1/2 x 23

Manufacturing Process:
Stretch Blow Molding

Base Width (A) Base Deep (C):
 3.010 ± 0.050 1.665 ± 0.050

Case Pack: **196**

Stock Material:



Overflow Capacity:
484 - 507 ml (16.4 - 17.2 oz)

Overall Height (B):
 7.870 ± 0.050

Case Weight (lb): **18.5 ± 0.43**

Rev #2 03/2016

Drawing not exactly to size.