



Drawing:  
**6 oz Sleek Cylinder 24/410**

Stock Code:  
**000600490240000**

Manufacturing Process:  
**Extrusion Blow Molding**

Overflow Capacity:  
**189 - 201 ml (6.4 - 6.8 oz)**

Gram Weight:  
**22 ± 2**

Neck Finish:  
**24/410**

Base Width (A):  
**1.880 ± 0.050**

Overall Height (B):  
**5.305 ± 0.050**

Max Print Area (Height):  
**4.000"**

Max Print Area (Width):  
**5.625"**

Case Pack: **571**

Case Weight (lb): **30.5 ± 2.5**

Cases Per Pallet: **16**

Box Dimensions:  
**24 7/16 x 18 1/2 x 23**

Stock Material:



**CLASSIC CONTAINERS INC**  
1700 S. Hellman Ave.  
Ontario, CA 91761  
Phone: 909-930-3610  
e-mail: info@classiccontainers.com  
[www.classiccontainers.com](http://www.classiccontainers.com)

### FRONT VIEW

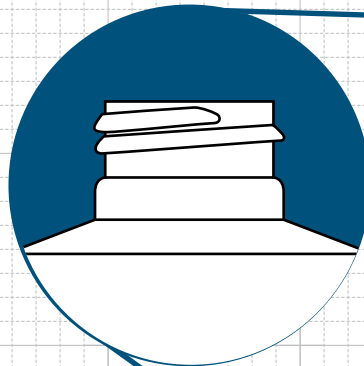
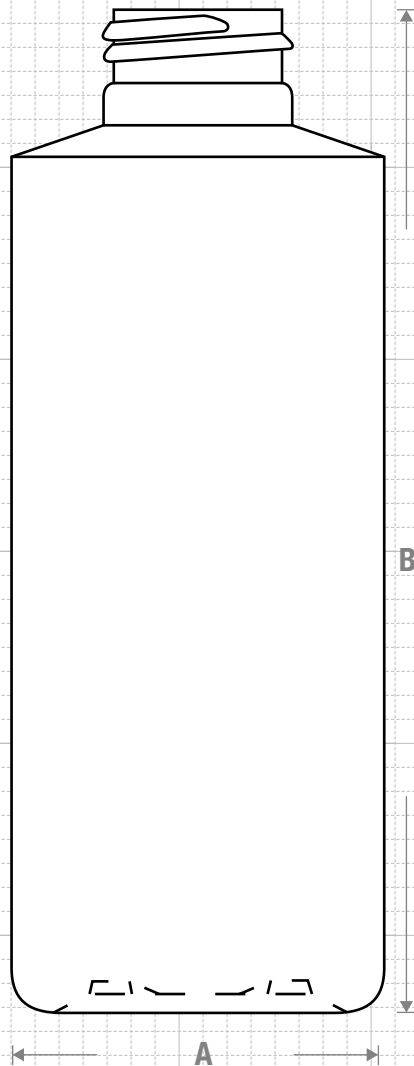

### NECK & THREAD DETAIL

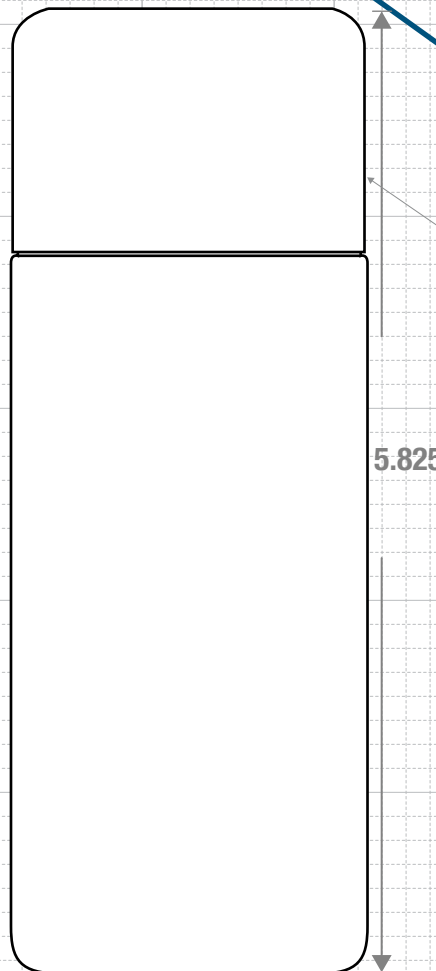
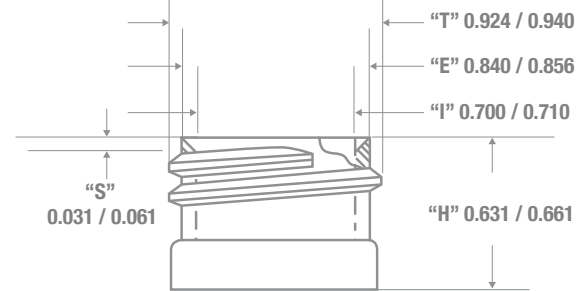

Dome Cap On  
6 oz Sleek Cylinder

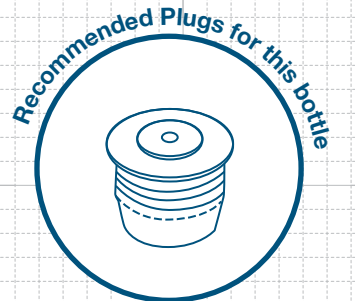

### FRICITION FIT

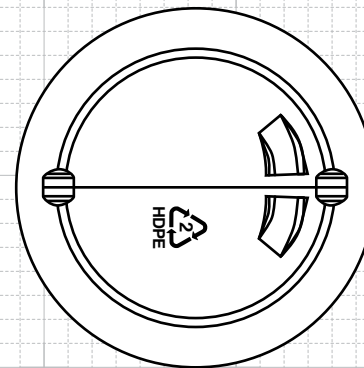

### BOTTOM VIEW

**Other Material Options**  
Stock Material: **MD/PE**  
Case Pack: **528**  
Case Weight (lb): **28.5± 2.3**

# PRINTING SPECIFICATIONS: 6 oz Sleek Cylinder 24/410

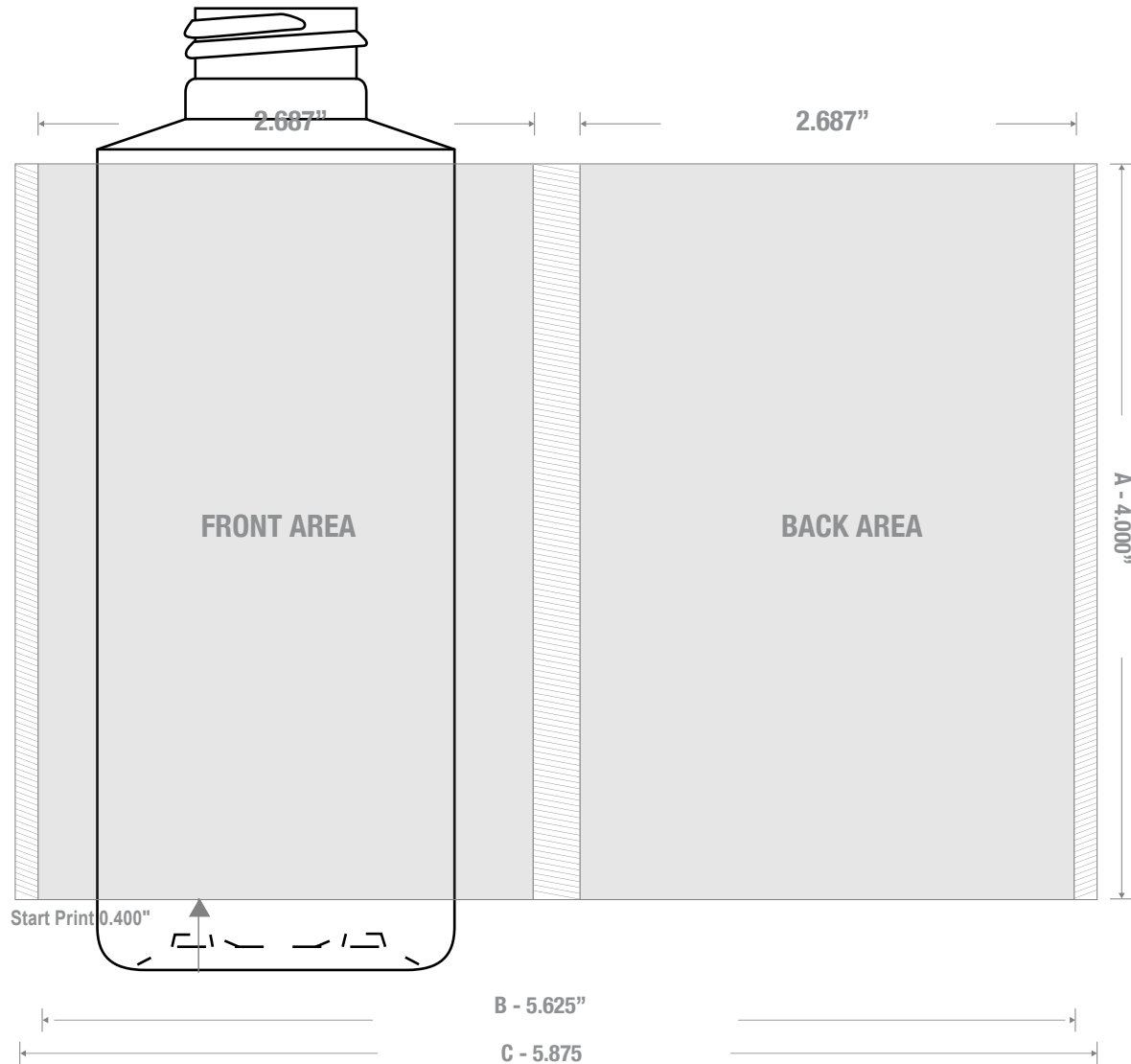

1700 S Hellman Ave, Ontario, California 91761  
Phone: (909) 930-3610 | Fax: (909) 930-3640  
e-mail: [info@classiccontainers.com](mailto:info@classiccontainers.com)  
[www.classiccontainers.com](http://www.classiccontainers.com)

A - Total Height.  
B - Max. Decorating Area.  
C - Total bottle circumference.  
☒ - Unprintable area.