



Drawing:  
1 oz Cylinder Round Tall  
20/410

Stock Code:  
000100030200000

Manufacturing Process:  
Injection Blow Molding

Overflow Capacity:  
38.35 +/- 2.95 ml and 1.3 +/- 1 oz

Gram Weight:  
6.0 ± 0.5

Neck Finish:  
20/410

Base Width (A):  
1.160 ± 0.050

Overall Height (B):  
2.900 ± 0.050

Max Print Area (Height):  
1.860"

Max Print Area (Width):  
3.437"

Case Pack: 1660

Case Weight (lb): 24.1 ± 1.8

Cases Per Pallet: 25

Box Dimensions:  
23 5/8 x 15 9/16 x 17

Stock Material:



**CLASSIC CONTAINERS INC**  
1700 S. Hellman Ave.  
Ontario, CA 91761  
Phone: 909-930-3610  
e-mail: info@classiccontainers.com  
www.classiccontainers.com

### FRONT VIEW

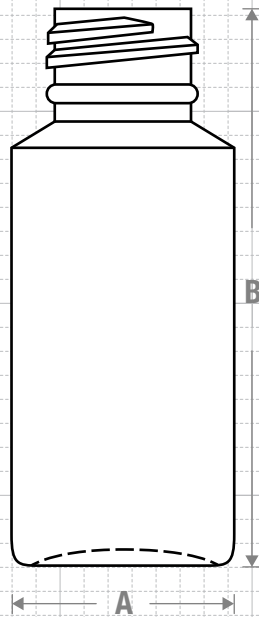

### NECK & THREAD DETAIL

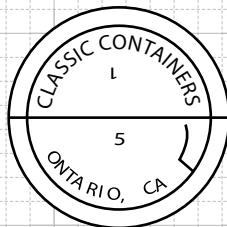
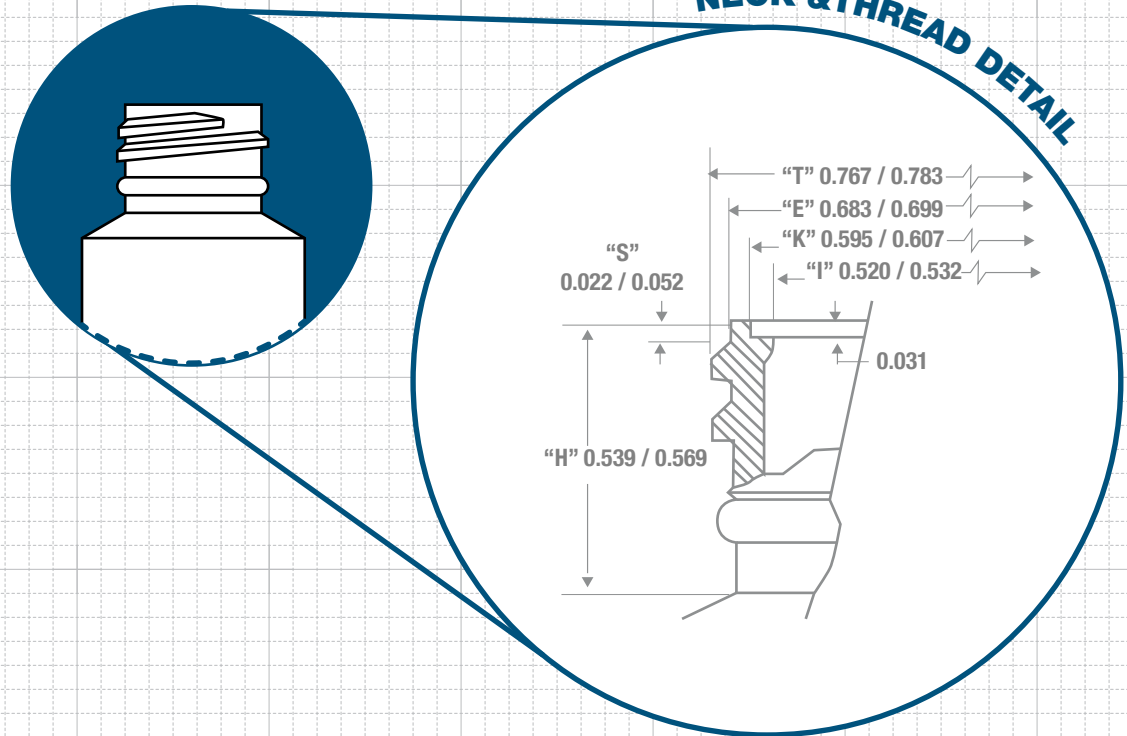

### BOTTOM VIEW

Recommended Plugs for this bottle

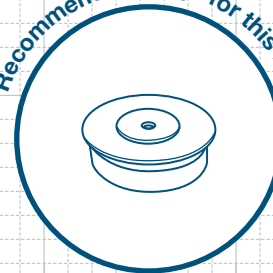

Recommended Plugs for this bottle

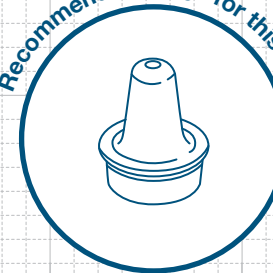

### SNAP FIT

# PRINTING SPECIFICATIONS: 1 OZ CYLINDER ROUND TALL 20/410

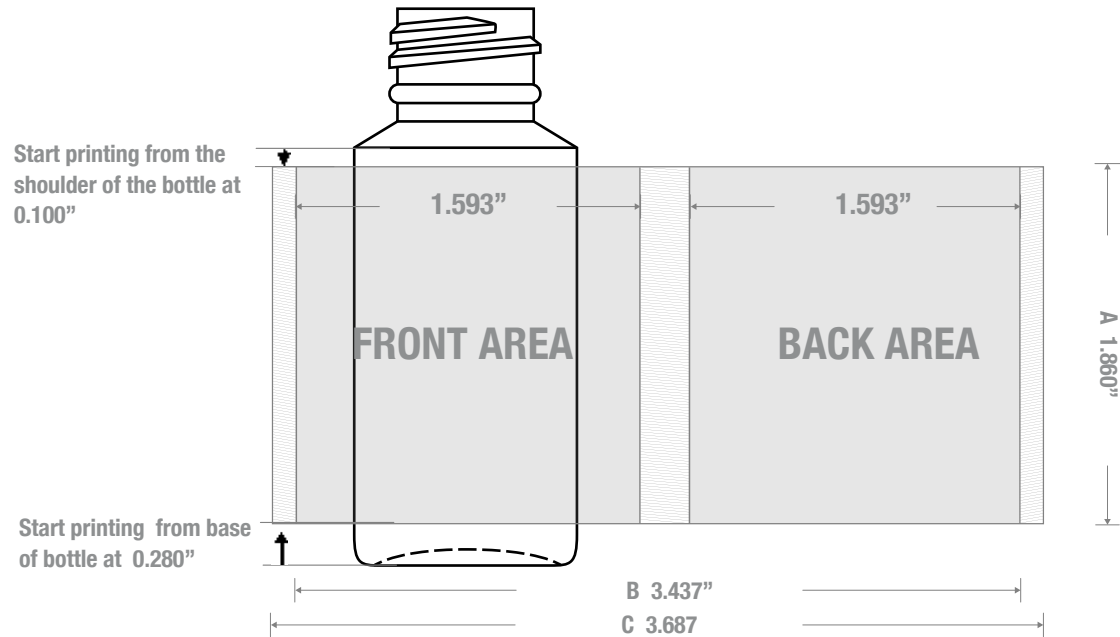

1700 S Hellman Ave, Ontario, California 91761  
 Phone: (909) 930-3610 | Fax: (909) 930-3640  
 e-mail: [info@classiccontainers.com](mailto:info@classiccontainers.com)  
[www.classiccontainers.com](http://www.classiccontainers.com)

**A - Total Height.**  
**B - Max. Decorating Area.**  
**C - Total bottle circumference.**  
 [Hatched Box] - Unprintable area.

# LABELING SPECIFICATIONS: 1 OZ CYLINDER ROUND TALL 20/410

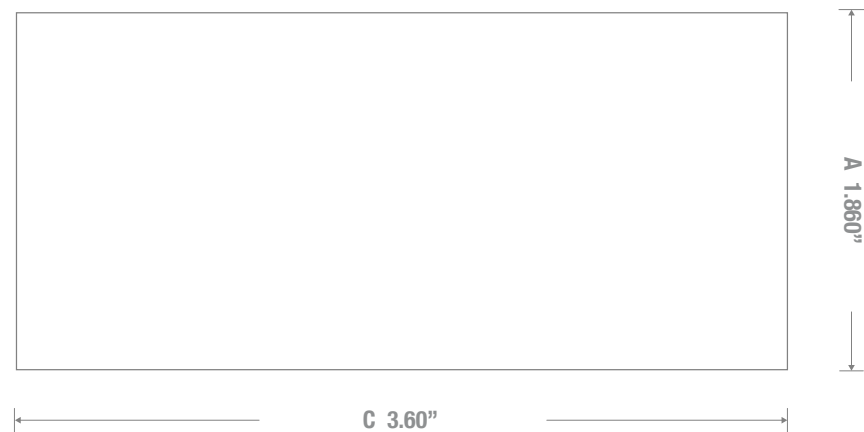

1700 S Hellman Ave, Ontario, California 91761  
Phone: (909) 930-3610 | Fax: (909) 930-3640  
e-mail: [info@classiccontainers.com](mailto:info@classiccontainers.com)  
[www.classiccontainers.com](http://www.classiccontainers.com)

**A - Total Height.**

**C - Total bottle circumference.**